

# Nexon.ev

game — changer







# game — changing design

A stunning new design that  
commands attention.



## smart digital DRLs

Make your presence felt through the signature DRLs with welcome and goodbye sequence and charging indicator.



## smart digital X factor

The iconic X factor with a welcome and goodbye sequence lends a sleek digital look.

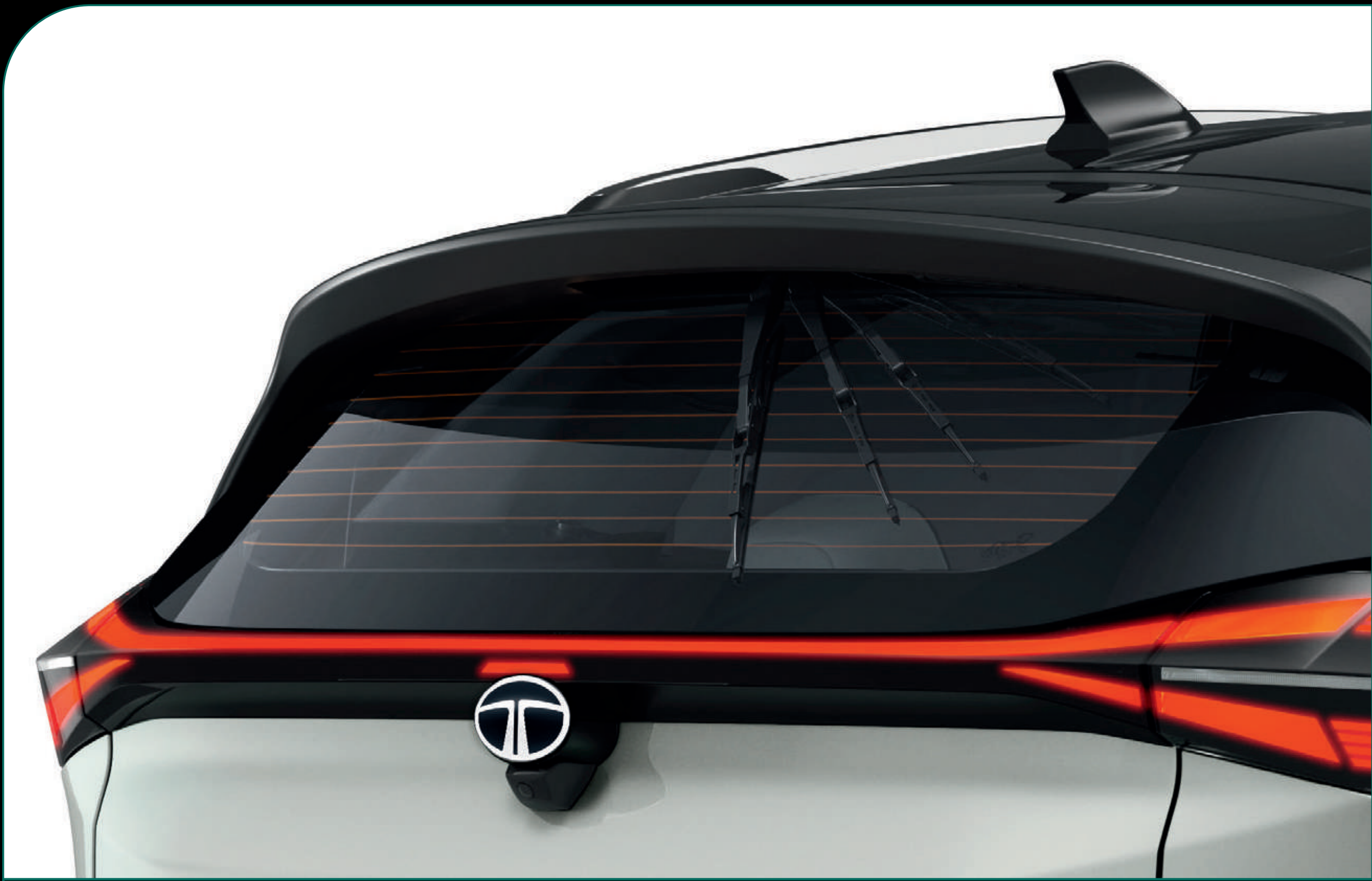

## hidden rear wipers

Better coverage for better visibility.



## digital dashboard

A dynamic digital dashboard that elevates your cabin experience.



## R16 alloy wheels

Glide through with aero inserts on R16 alloy wheels.

## smart digital steering wheel

Stylish 2-spoke back-lit steering wheel.



## phygital control panel

Touch meets digital control.



## smart digital shifter

Seamless drive selection for quick responsiveness.



for —  
different  
personas



Your unique personality will now  
reflect in your car.

# empowered —

For those who are always driven to make a difference.





# fearless

For those with an unflinching,  
unshakeable belief in themselves  
that inspires others.



# creative

For those who always bring a unique and original perspective, expressing it in all its forms.





game —  
changing  
innovation

Reimagine what your car can do.

# V2V charging



Charge another EV, anywhere with vehicle-to-vehicle charging<sup>^^</sup>.



## V2L technology\*\*\*

Power your gadgets with the power of your EV.



Reimagine your car as a power bank.



Never out of power to suit your lifestyle.

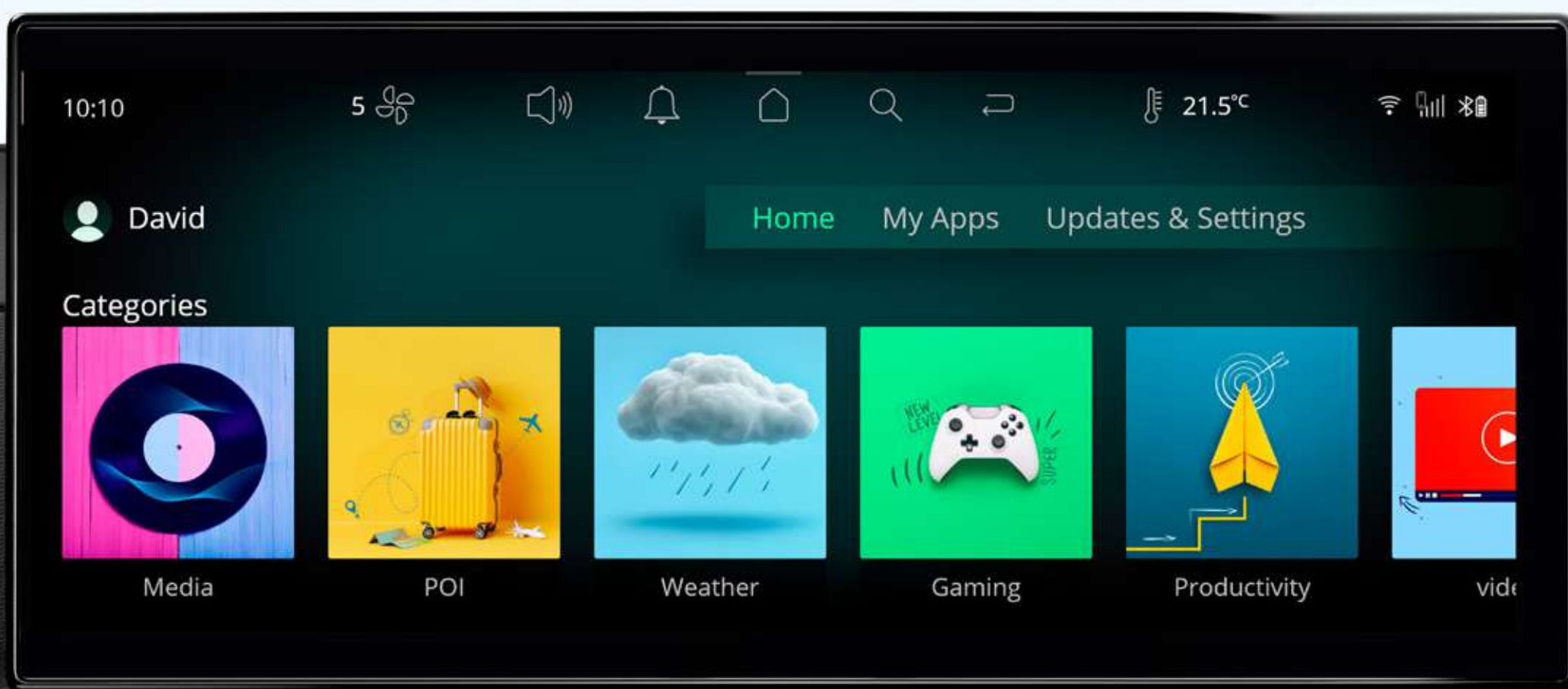

## Arcade.ev\*\*

A true app suite to download your favourite music, video, productivity, navigation and gaming apps.

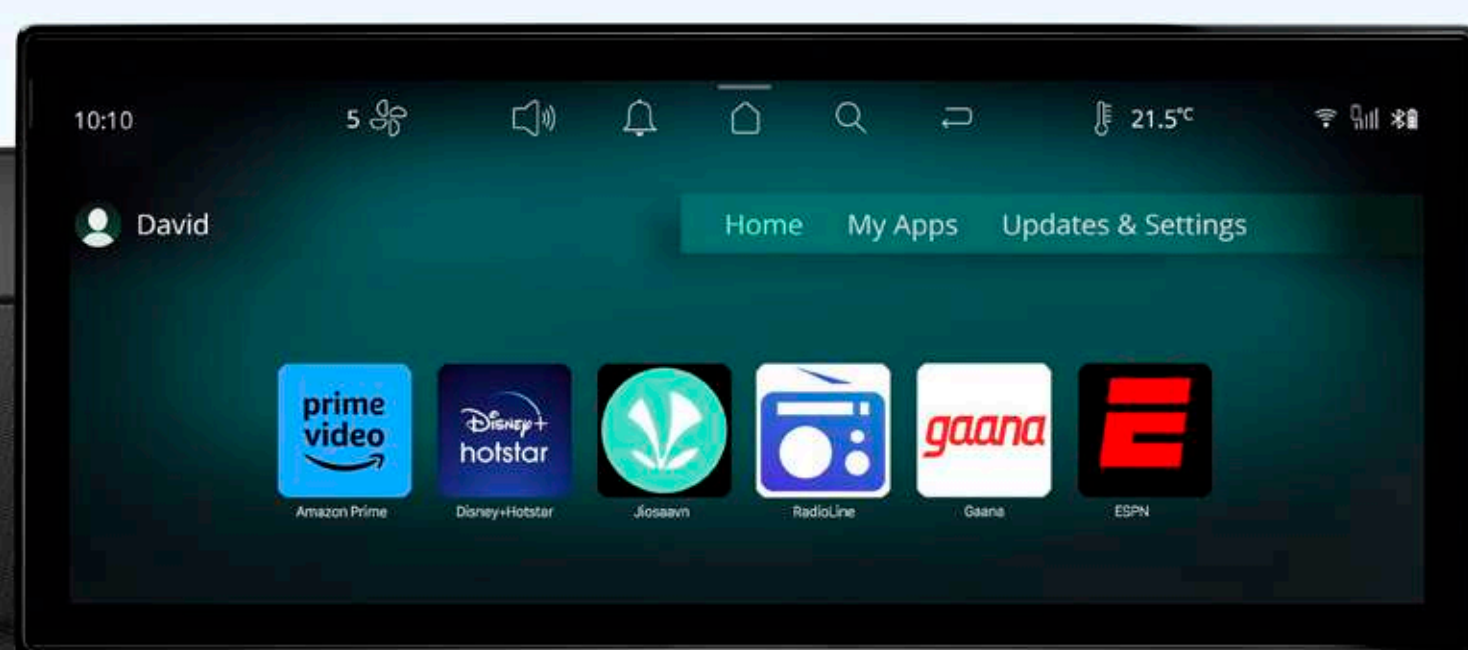

15+ apps today and more tomorrow.

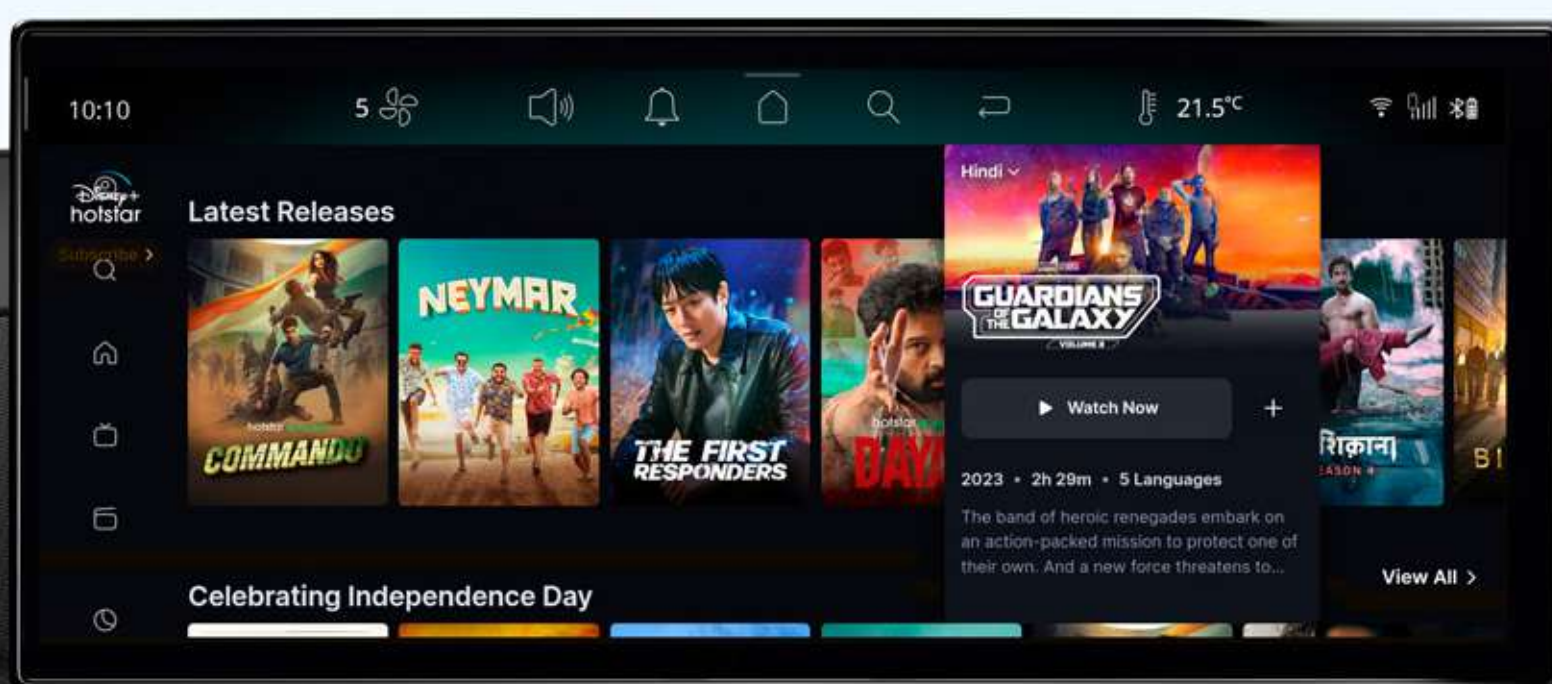

Imagine watching your favourite OTT series in your all-new Nexon.ev.



# game — changing technology

The next big thing in tech is already here. Are you game?

# 31.24 cm cinematic touchscreen



An immersive, unparalleled  
cinematic experience awaits you.





## JBL cinematic sound system

Spatial, immersive JBL audio for a 360° 3D surround sound experience.

## high quality speaker

9 high quality speakers including external sub-woofer.



## audio modes

Multiple audio modes that enhance in-vehicle acoustic experience.

## cinematic experience

An immersive experience like no other.



## kids sleeping in back

Stay entertained without disturbing the kids.





## digital cockpit

High-definition fully reconfigurable instrument cluster.



Multi-dial view in cluster.

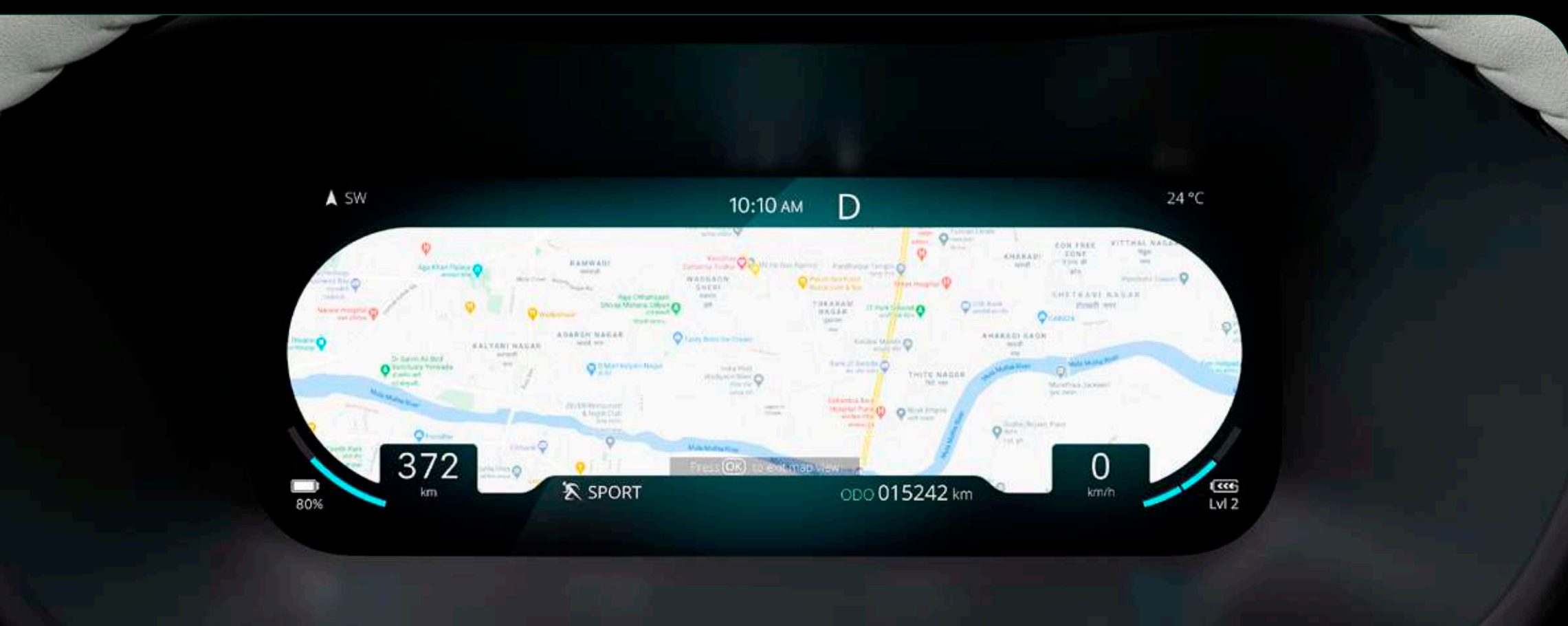

Embedded maps for a safe, intuitive and enriched driving experience.



## wireless charger

Charging with no strings attached.

## wireless Android Auto™ and Apple CarPlay™

Be it Android or Apple, connect wirelessly.



## air purifier

Breathe pure, drive refreshed.

## electronic parking brake

Engage your parking brake with a switch.





## auto dimming IRVM

Don't let the lights behind you blind you.

## OTA updates

Stay new forever with over the air updates.



## rain sensing wiper

Automatic wipers for unexpected rain showers.



## auto headlamps

Automatic headlamps that light up your drives.





# game — changing safety

A new benchmark in safety to keep your family safe and sound.



## fortified cabin

Based on BNCAP 5 star rated platform.



## 360° surround view camera system

Get a 360° view of everything that surrounds you.



## Tyre Pressure Monitoring System (TPMS)

Enjoy the road and the smooth drive while we're monitoring your tyres to keep the good times rolling.



## SOS call###

In-cabin emergency assistance button.

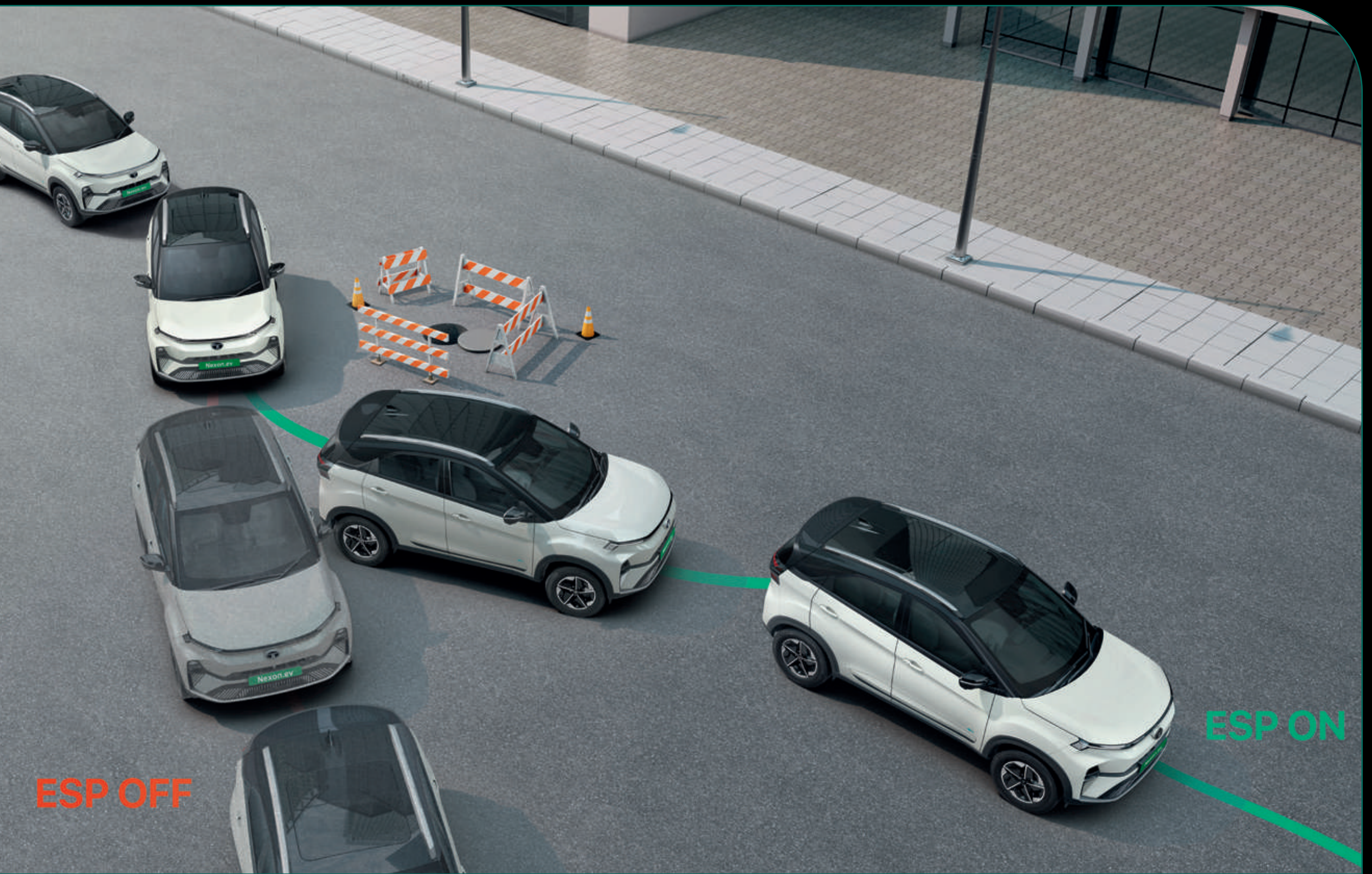

## ESP with i-VBAC

Advanced dynamic stability for precise handling.

## 6 airbags

All-round safety for all-round peace-of-mind.



## blind spot view monitor

Additional safety when you need to take a turn.

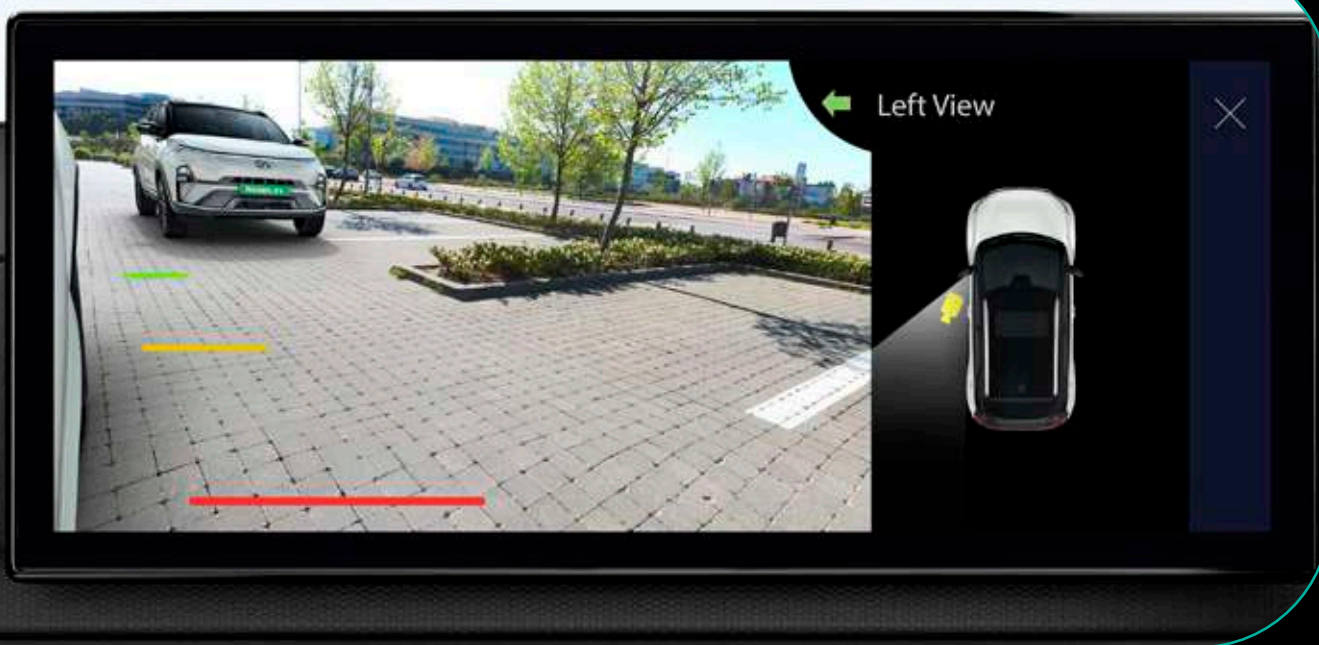

## hill ascent & descent control

Holds for 2 seconds when you stop on an incline and controls your car's speed on slope declines.



## auto hold

Keeps your car at a complete stop until you press the accelerator.

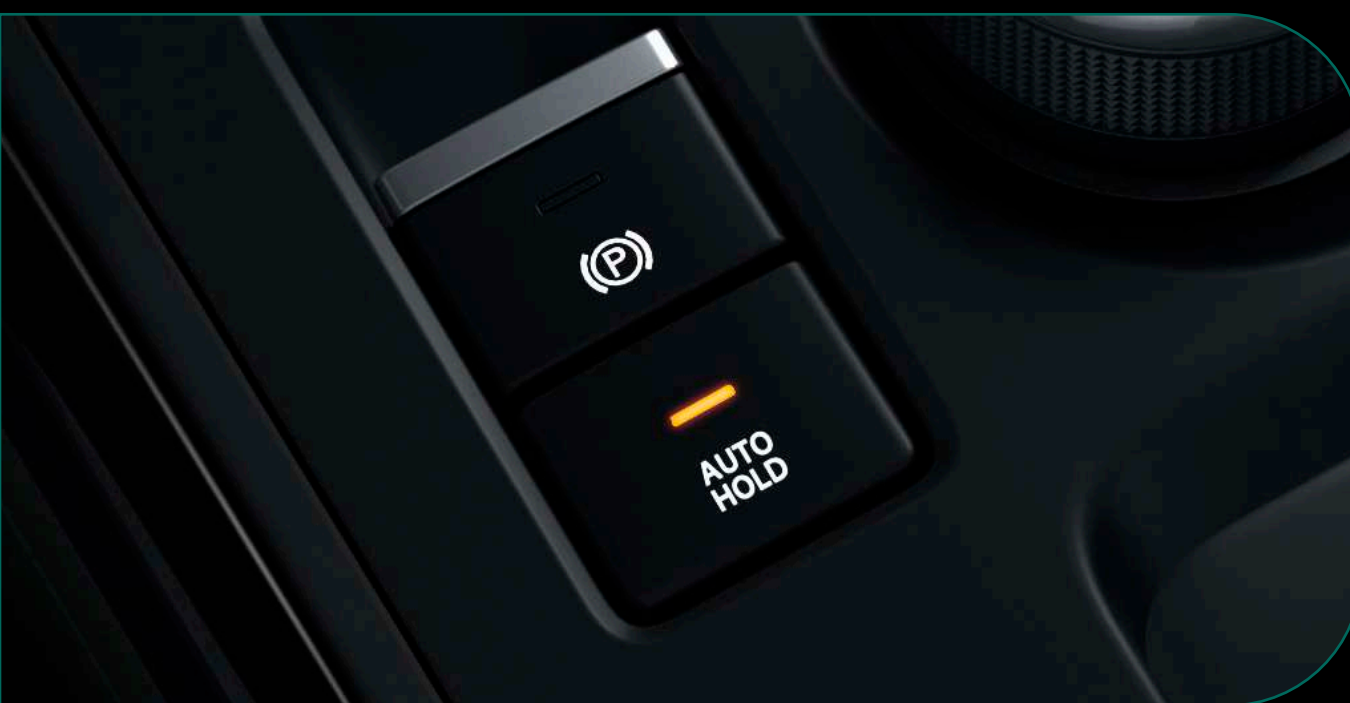

## all disc brakes

Increased braking efficiency, for more control.



## front parking sensor

Parking made easier with front assist sensors.







# game — changing comfort

Slip into a world of plushness & comfort.



## voice assisted panoramic sunroof

Enjoy the sky above and set the perfect mood for your journey, all at your command.



## frunk

Extra storage, extra style, right under the hood.



## **bolstered ultra comfort seats with ventilation**

Extra cushioned seats for extra comfort on drives.



## **60:40 rear seats and centre armrest**

Customise your comfort and storage.



## boot space

Ergonomic boot space to carry everything you need.

## rear AC vents

Keep passengers in the back as cool and comfortable as you are.

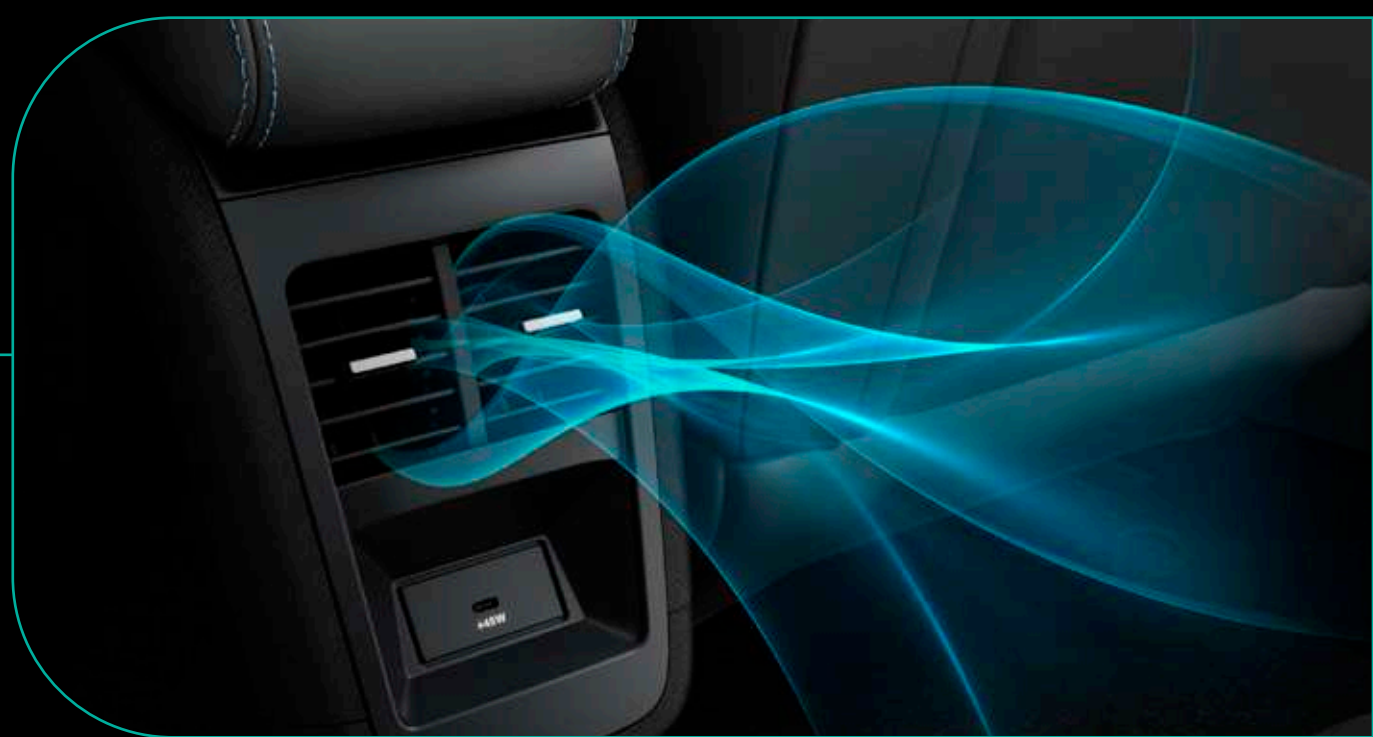

## grand centre console

Let's take some pressure off those long drives.

## cooled glove box

For those who like to keep things chill.



## USB type C (45W)

Fast charge your gadgets on-the-go.



# game — changing performance

Elevate your drives with  
gamechanging performance.

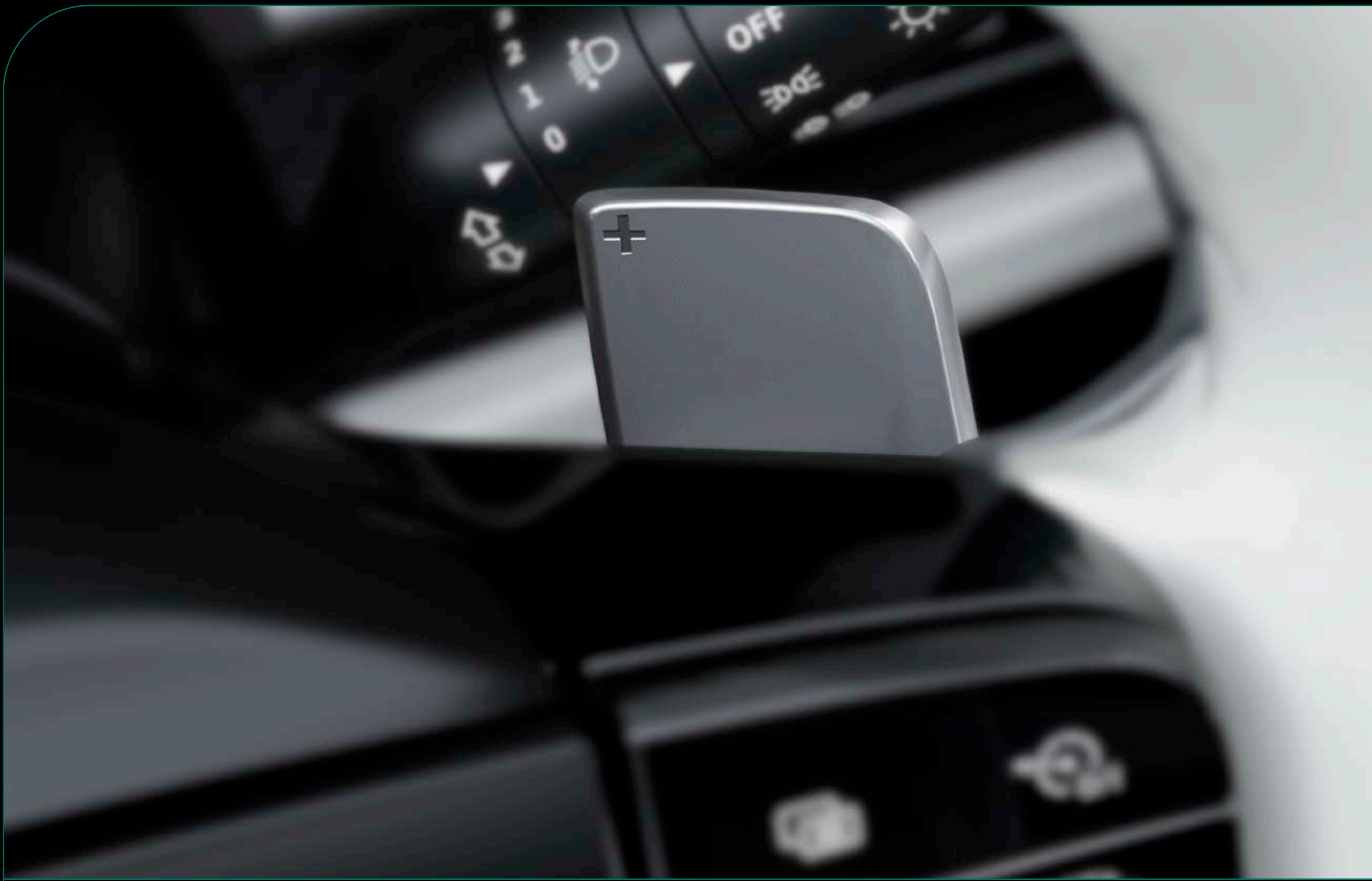

## paddle shifters

Enjoy intuitive on-the-go energy regen.



## multi drive modes - eco, city & sport

Whatever your driving style, we've got you covered.

# Nexon.ev — architecture

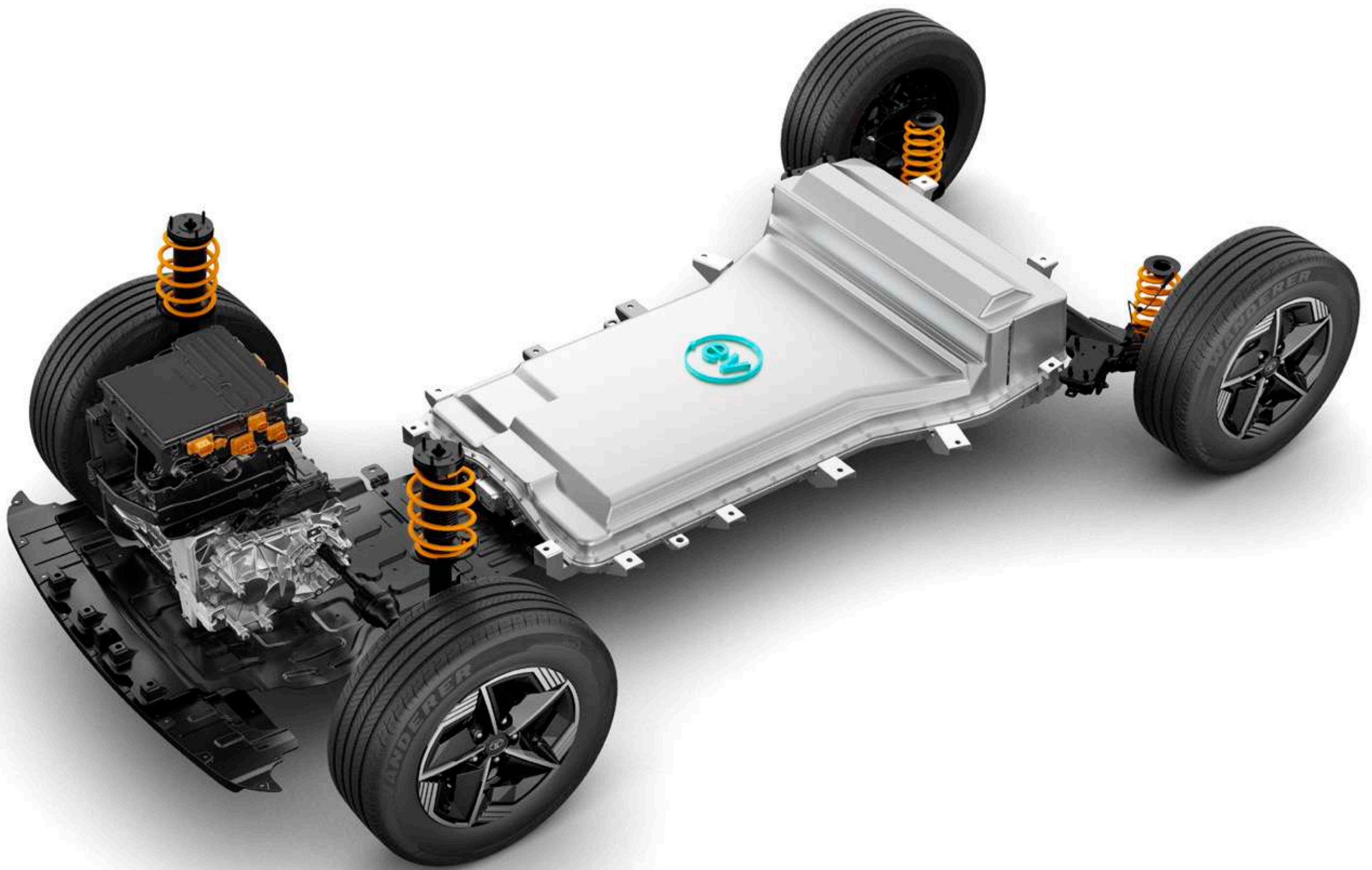

## range

---

Say yes to long drives! 489<sup>#</sup> km in a single charge.

## power output of 110 kW

---

Unleash the power of electric.

## IP67

---

Drive worry-free with high ingress protection standards.

## 0-100 in 8.9<sup>s</sup>

---

Fast when you need it to be.

## instant torque of 215Nm

---

Instant torque equals instant fun.

— performance

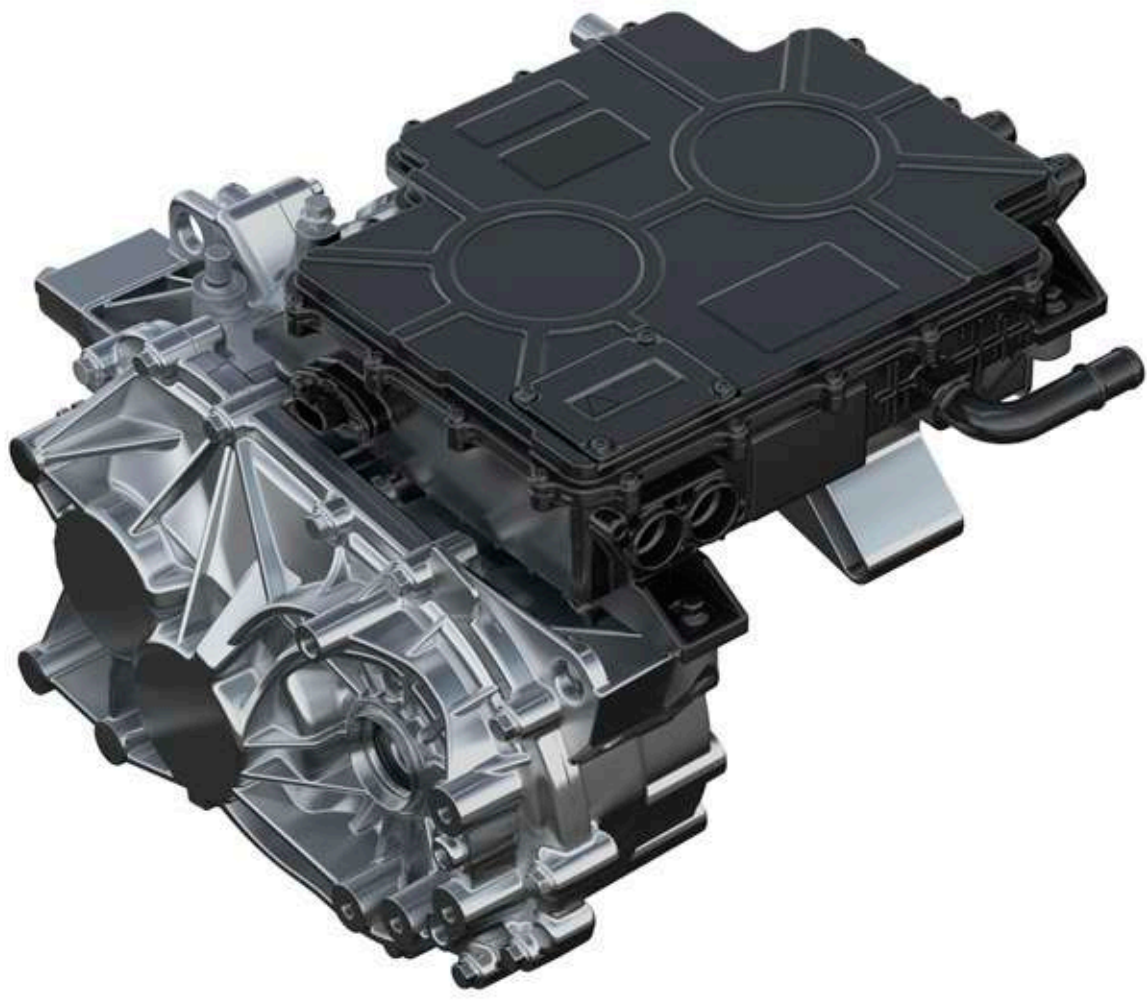

## all-new gen-2 motor

---

Where performance meets efficiency.

## liquid cooled battery pack

---

Long lasting battery, ideally suited for Indian driving conditions.

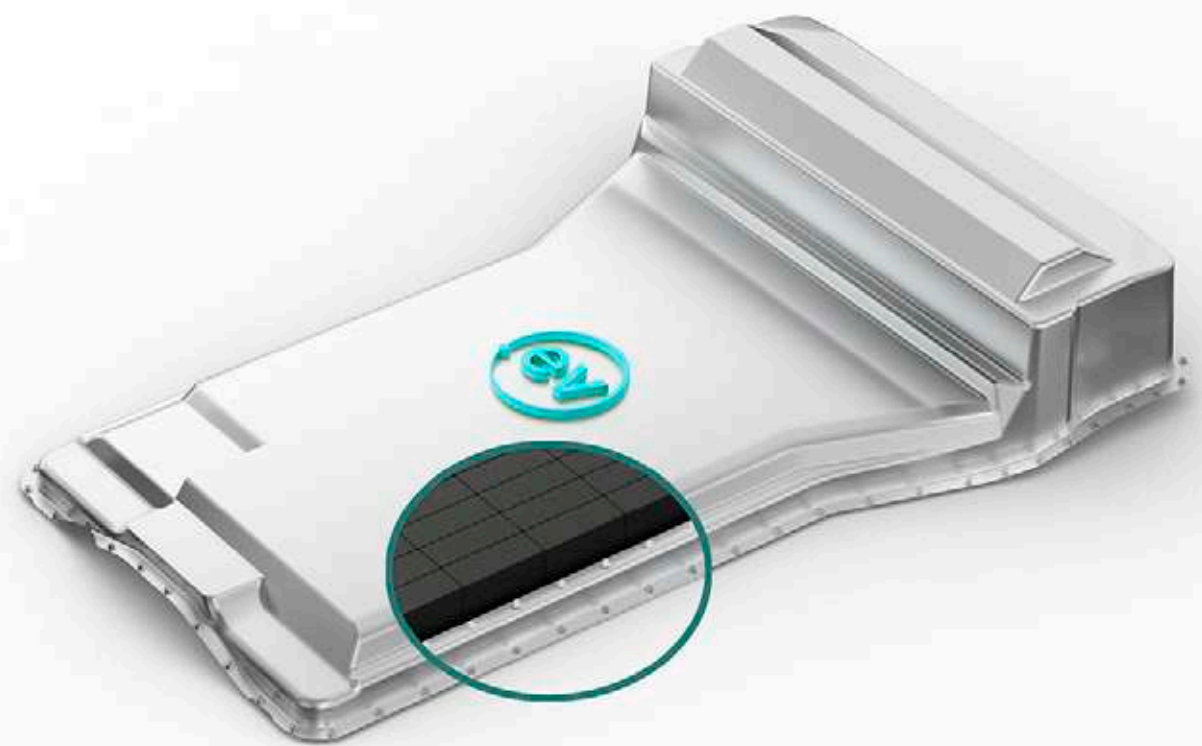

for illustration purposes only

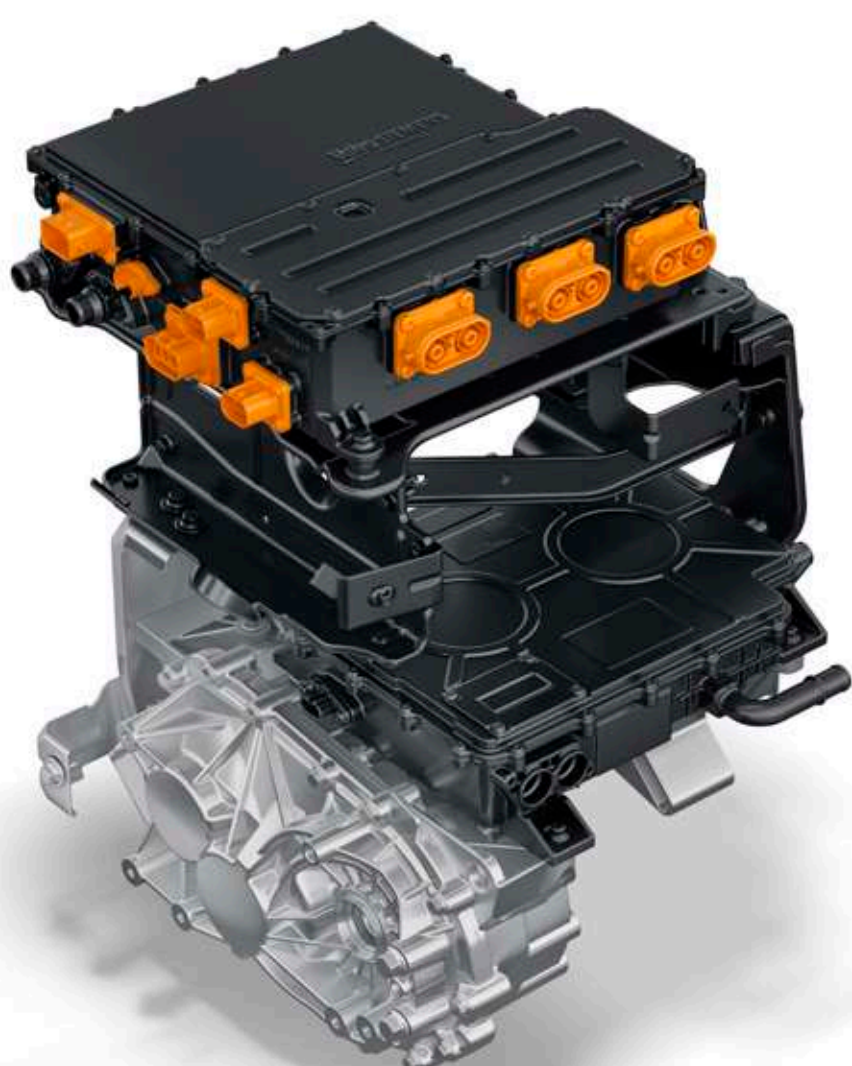

## power electronics

---

Smart algorithms to control vehicle electronics.



# charging —

Enjoy hassle-free drives with multiple charging options.



## home charging

### 7.2kW AC home wallbox charger

Charge conveniently at home with AC fast charger.  
SOC 10% - 100% in 6 hours 36 minutes\* for 45

### AC home wallbox charger

Charge efficiently.  
SOC 10% - 100% in 17 hours 36 minutes\* for 45

## on-road charging

### DC fast charger

Fast charge (SOC 10% - 80%) with 60kW DC fast charger in just 40 minutes\* for 45

### 15A portable charger

Charge anywhere from a 15A socket, SOC 10% - 100% in 17 hours 36 minutes\* for 45

# multiple colour choices to pick from

## empowered

pristine white



daytona grey



intensi teal



flame red



empowered oxide



fearless purple

## fearless

pristine white



daytona grey



flame red



## creative

pristine white



daytona grey



flame red



creative ocean

## Nexon.ev 45 - technical specifications and features

Electric Drivetrain		45
Motor (Type)	Permanent magnet synchronous AC motor	
Electric motor power (kW)	110	
Electric motor torque (Nm)	215	
Multi Drive Modes	Multi drive mode - City, Sport & Eco	
Battery pack (kWh)	45	
Thermal management system	Liquid Cooled system	
Ingress protection for motor & battery pack	IP67	
Acceleration (0-100 km/h in sec)	8.9^	
Emission	Zero tailpipe emission	
Smart Drive Features		
Smart Drive Features Smart regenerative braking	Multi-mode regenerative braking   4 Levels (Level 0 - 1 - 2 - 3) 0 - No regen   3 - Max. regen	
Paddle Shifters to control Regen Modes	✓	
Dimensions		
Length x Width x Height (mm)	3994 × 1811 × 1616	
Wheelbase (mm)	2498	
Unladen ground clearance (mm)	190	
Boot space (Litre)	350	
Steering		
Steering	Electrically power assisted	
Turning circle radius (m)	5.3	
Brakes		
Front, Rear	All - Disc	
Suspension		
Front Suspension	Independent MacPherson strut with coil spring	
Rear Suspension	Twist beam with dual path Strut	
Wheels & Tyres		
Size	215 /60 R16	
Low Rolling Resistance Tires	✓	
Charging		
Charging Standard	CCS2	
Portable charging cable	Yes	
Charging options	Home, 3.3 kW AC Wall Box, 7.2 kW AC Wall Box, DC Fast Charger	
Estimated regular charging time (SOC 10% to 100% from any 15A plug point)	17 hrs 36 min*	
Estimated regular charging time (SOC 10% to 100% from 7.2 kW AC fast charger)	6 hrs 36 min*	
Estimated fast charging time (SOC 10%-80%) from 60 kW DC fast charger	40 minutes*	
Warranty		
Battery pack and motor warranty	8 Year or 1,60,000 km (whichever is earlier)	
Vehicle warranty	3 Year or 1,25,000 km (whichever is earlier)	
Driving range		
Certified full charge range as per MIDC Part 1 + Part 2 (km)	489#	
C75 real-world range (km)	350-375*	

### creative 45

- Smart Digital DRLs
- LED Headlamps
- Smart Digital Shifter
- Smart Digital Steering Wheel
- 6 Airbags
- ESP with i-VBAC
- Electronic Parking Brake with Autohold
- Rear Disc Brakes
- Camera & Sensor Based Reverse Park Assist
- 17.78 cm Touchscreen Infotainment by Harman™
- 17.78 cm TFT Instrument Cluster
- Android Auto™ & Apple CarPlay™
- 4 Speakers
- Fully Automatic Climate Control (FATC)
- Push Button Start (PEPS)
- Paddle Shifter for Regen Modes
- Multi Drive Modes - Eco, City & Sport
- Power Window (4 doors)
- Electric ORVM
- Electric Tailgate Release
- Driver side Height Adjustable Seat
- 6.6 kW On-board Charger (Compatible Charging with AC Fast Charger)
- 3.3 kW AC Wall Box
- iRA.ev<sup>##</sup> & Smart Watch<sup>^^</sup> Connectivity
- Multiple Voice Assistants (Hey Tata, Siri, Google Assistant)
- Air Purifier
- iTPMS

### fearless 45

#### addition to creative 45

- LED Projector Headlamps
- Smart Digital X Factor
- Centre Position Lamp
- Sequential Indicators
- Front Fog Lamps with Cornering
- Electric ORVM with Autofold
- R16 Alloy Wheels with Aero Inserts
- 26.03 cm Cinematic Touchscreen
- 26.03 cm Digital Cockpit
- Navigation in Cockpit - Driver View Maps
- Android Auto™ & Apple CarPlay™ over WiFi
- 4 Speakers + 4 Tweeters
- HD Camera Based Reverse Park Assist
- Hidden Rear Wiper & Washer with Defogger
- Front & Rear Fast Charge C Type 45W
- Rear AC Vents
- Roof Rails
- Cooled & Illuminated Glove Box
- Leatherette Wrapped Steering Wheel
- Alexa Voice Assistant
- Express Cooling
- Driver One Touch Auto Up/ Down Window with Safety

### empowered 45

#### addition to fearless 45

- 360 deg Camera Surround View System
- Blind Spot View Monitor
- Front Parking Sensor
- Voice Assisted Electric Sunroof
- Tire Pressure Monitoring System
- AudioworX – JBL Audio Modes
- Front Armrest
- Cruise Control
- Wireless Smartphone Charger
- Auto Dimming IRVM
- Leatherette seats
- Rear Seat 60:40 Split
- Rear Seat Central Armrest
- Rain Sensing Wipers
- Auto Headlamps
- Spare wheel

### empowered + 45

#### addition to empowered 45

- Voice Assisted Panoramic Sunroof
- Frunk
- 31.24 cm Cinematic Touchscreen
- SOS call
- V2V<sup>^^^</sup> Charging
- V2L<sup>\*\*\*</sup> Technology
- Welcome & Goodbye Sequence in Front & rear DRLs
- Charging Indicator in Front Centre Position Lamp
- Driver & Co-driver Ventilated Seats
- Air purifier with AQI sensor & display
- JBL Cinematic Sound System (4 Speakers + 4 Tweeters + 1Subwoofer)
- Arcade.ev – App Suite
- 7.2 kW AC Fast Charger